

Data Sheet



Article number: 021816011240

Description: Clamp with bracket and rubber
SPGU 6011. 240/30 SK

Measures

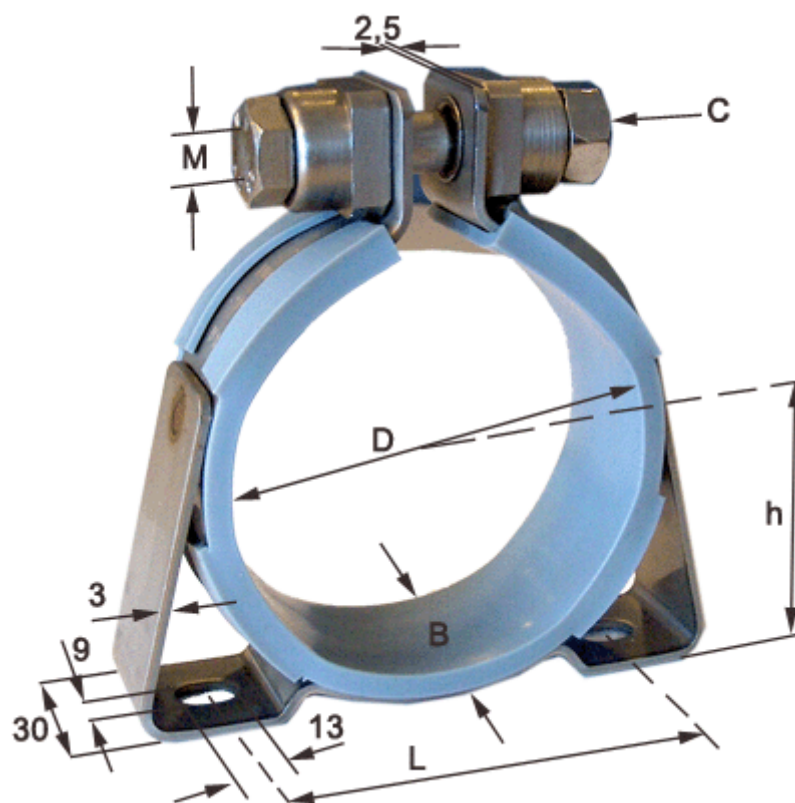

C (screw type) = SK hexagon screw

Diameter D = 240

h = 128

L = 216

Width B = 30